

X-Rail

X-Rail is a magnet track system with low voltage of 48V, available in the following versions: recessed trimless (only for plasterboard), surface or pendant. The 4 track conductors can be used for an on/off power supply circuit, or for a dimmable "Noise Free" circuit, as described in the wiring schemes on page 8. X-Gun, X-Dark and X-Line products are suitable for different needs of lighting. They are fixed into the X-Rail profile by the magnet and the click safety lock.

Magnet system

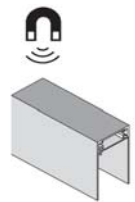

Bidirectional installation

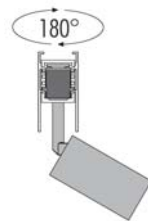

Click&Safety Lock

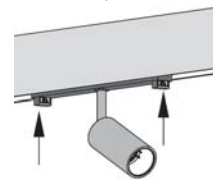

Adjustable

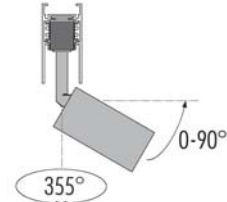

WIFI Technology by App



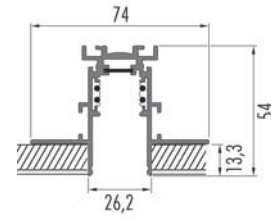

Recessed trimless *only for plasterboard*

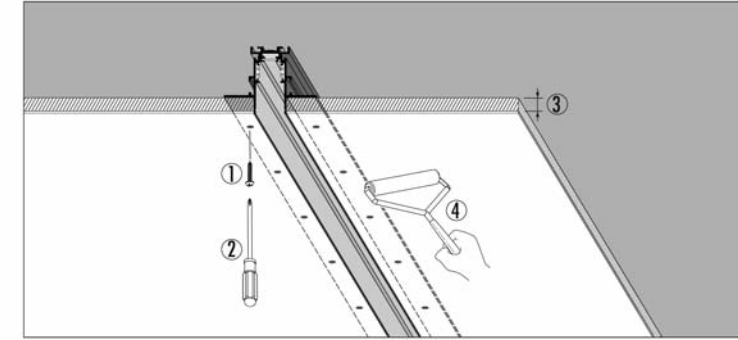

- 1 Screw
- 2 Screw Driver
- 3 Gypsum Board 13,3mm
- 4 Plastering

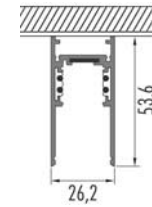

Surface

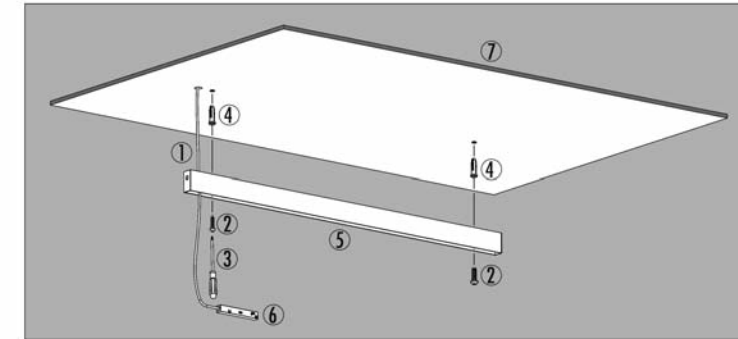

- 1 DC 48V Input
- 2 Screw
- 3 Screw Driver
- 4 Expansion Screw
- 5 Track
- 6 DC Connecting Box
- 7 Ceiling

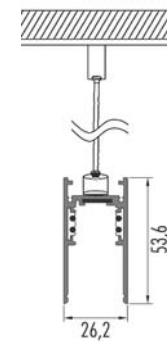

Pendant

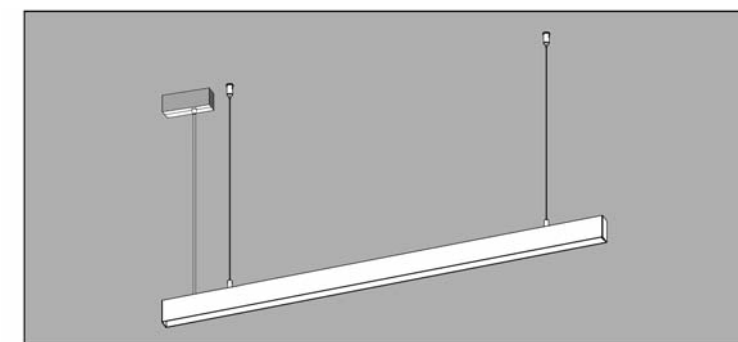

- 1 Steel cable
- 2 Mounting Plate
- 3 End cup for track
- 4 Track
- 5 Screw
- 6 Screw
- 7 DC Connecting Box

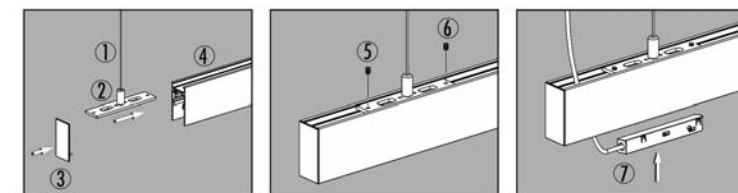

◀ Surface track installed on an exposed concrete ceiling by using an appropriate predisposition

X - Gun

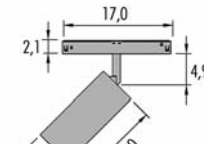
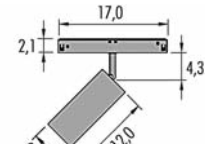
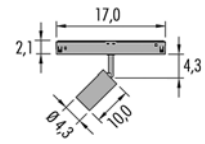
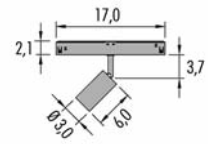

- 02 ● Black
- 06 ○ White
- CH ● Chrome
- GD ● Gold

- 02 ● Black
- 06 ○ White
- CH ● Chrome
- GD ● Gold

- 02 ● Black
- 06 ○ White

- 02 ● Black
- 06 ○ White

X - Dark

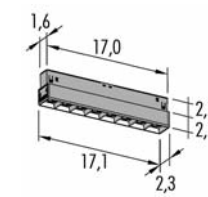

- 02 ● Black

X - Line

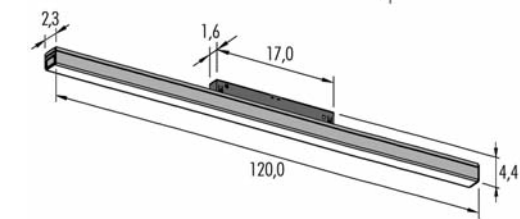
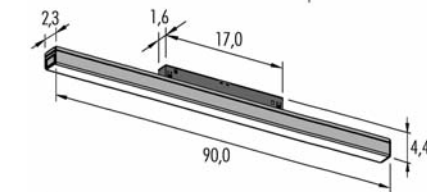
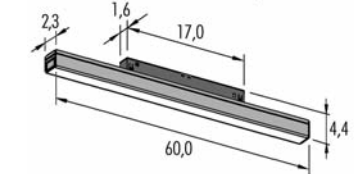
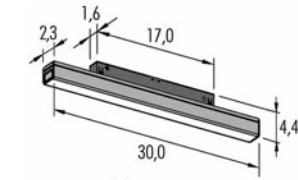
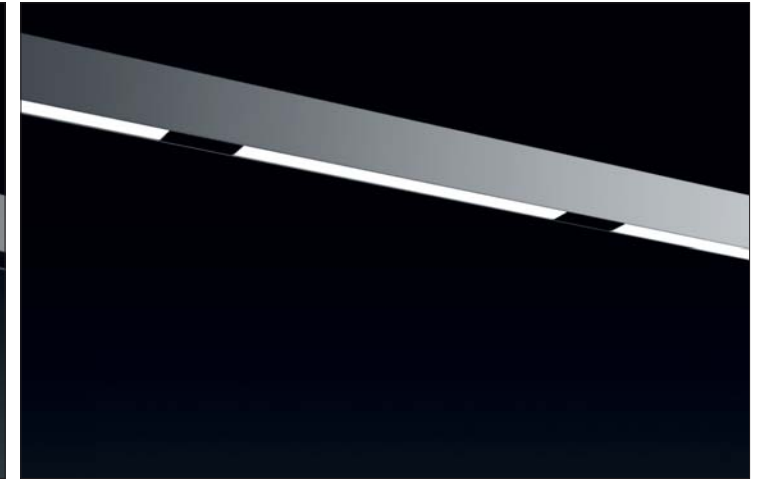

Devices Installation Scheme

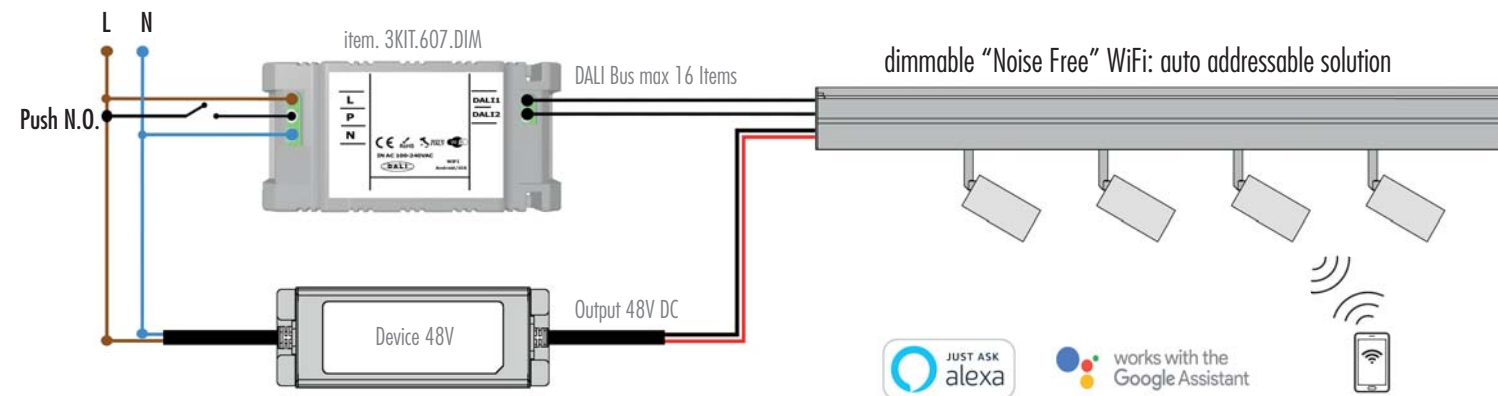
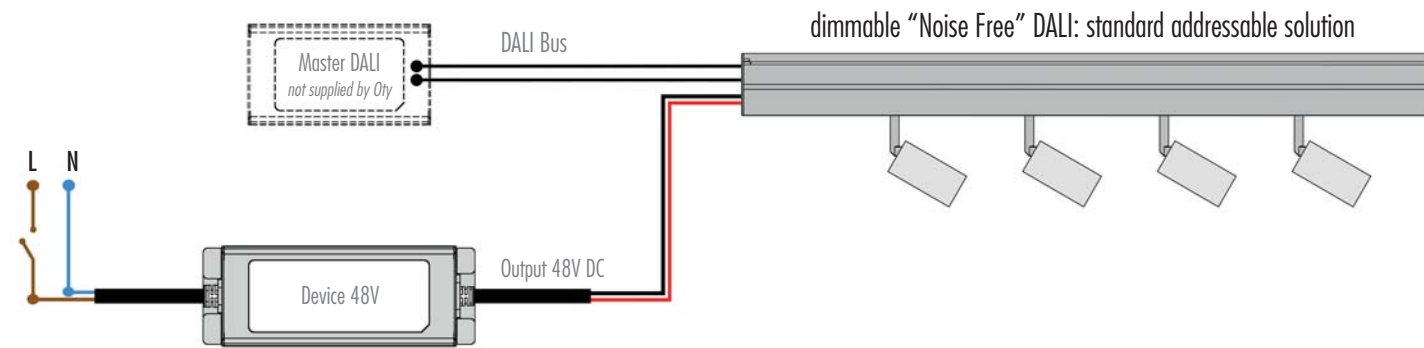
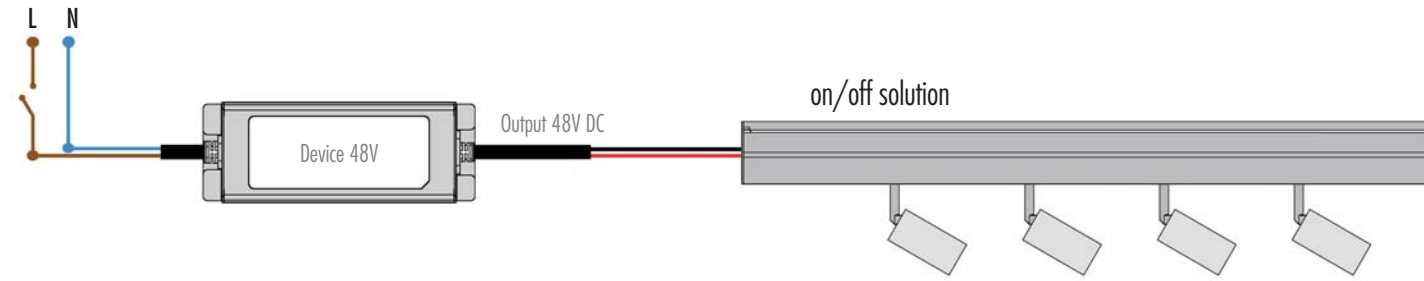

Drop voltage table

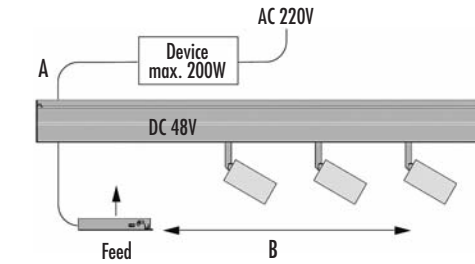

Device	(A)	5 mt.	10 mt.	20 mt.	30 mt.
75W	(B)	50 mt.	50 mt.	40 mt.	30 mt.
100W	(B)	50 mt.	50 mt.	30 mt.	10 mt.
150W	(B)	20 mt.	15 mt.	5 mt.	—
200W	(B)	15 mt.	10 mt.	—	—

(A) Distance Device/Feed Unit
(B) Distance Feed Unit/Spot

Technical characteristics of the devices for 48V Track

Code	W	Size (mm)	CV	Connectable fixtures	Max distance	Cable section	Tech. Info
3KIT.048.075	75	180x63x36	48V	Max: 60W	See chart here above	2.5mm ²	100-305V 47-63Hz
3KIT.048.100	100	199x63x36	48V	Max: 70W	See chart here above	2.5mm ²	100-305V 47-63Hz
3KIT.048.150	150	219x63x36	48V	Max: 105W	See chart here above	2.5mm ²	100-305V 47-63Hz
3KIT.048.200	200	244x71x38	48V	Max: 150W	See chart here above	2.5mm ²	100-305V 47-63Hz

Led warranty ONLY when used together with devices bought from Oty srl

WiFi device "Noise Free" to dim the light

Code	Size (mm)
3KIT.607.DIM	80x40x25mm

It works by WiFi with smart phone, Google Assistant or Amazon Alexa.
App on request.



X-Gun 1 $\varnothing 3,0$

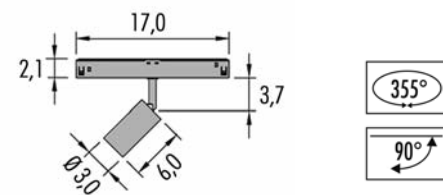

IP20	MC-E=3	CE
48V	LED 3W	CRI>95
3XG1.02	on/off	
3XG1.G2	dimmable	
Led color	Nominal lm	Beam spread
2 = 2700°K	427	S = 24°
3 = 3000°K	430	T = 10°

- Attention, before ordering the item:
- 1- Choose the appropriate 48V devices (75-100-150-200W) available on page 9, paying attention to the drop voltage table;
 - 2- If you need to dim the light, choose the two options:
 - a. by a Master DALI (item not supplied by Oty);
 - b. by our dimming device 3KIT.607.DIM, available on page 9.
 - 3- All our items are "Noise Free" dimming if installed as explained on page 8.

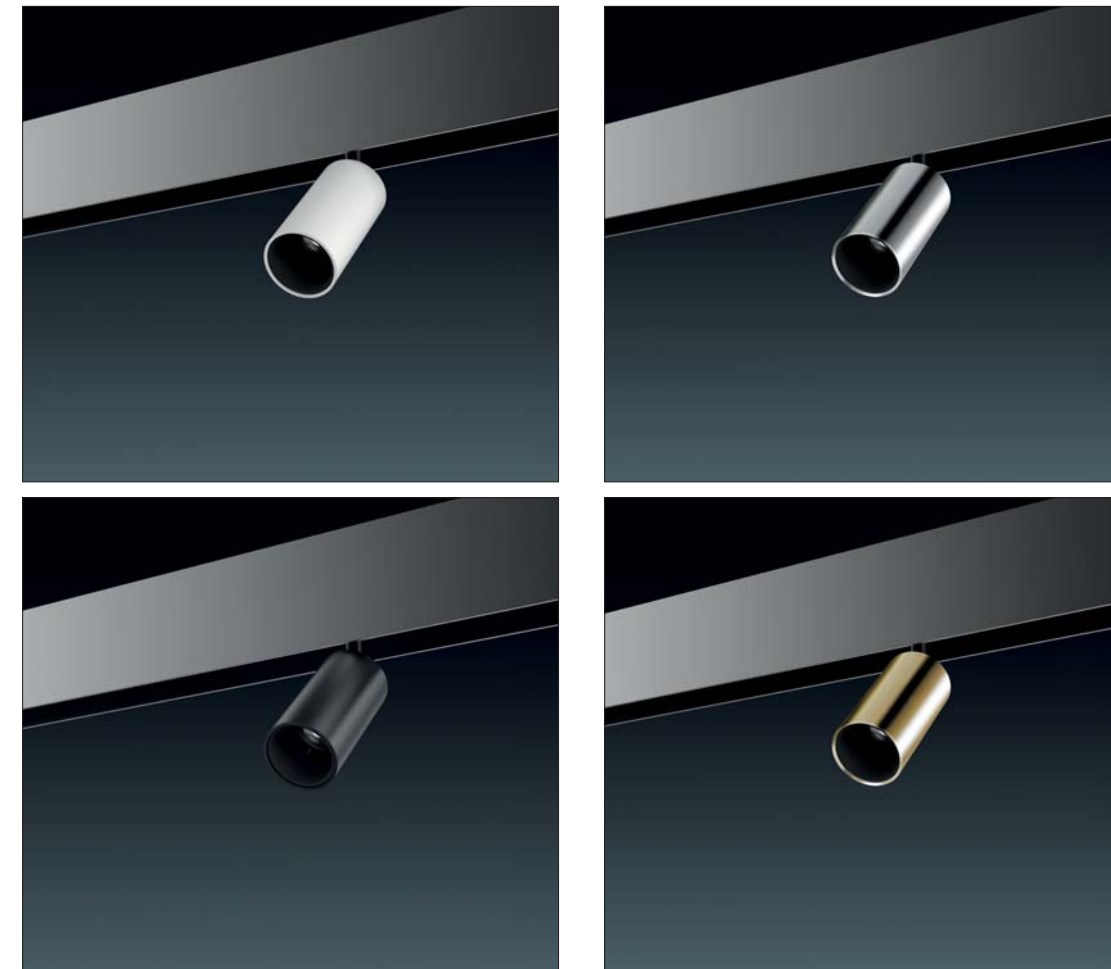

- Frame
- 02 ● Black
- 06 ○ White
- CH ● Chrome
- GD ● Gold



Standard: X-Gun is supplied with Anti-glare Ring



Option: Cross Anti-glare Ring

1XG1.C30.02

X-Gun 2 $\varnothing 4,3$

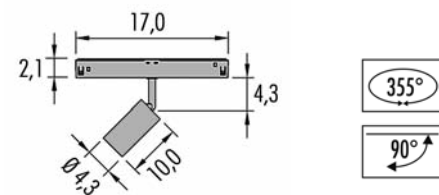

IP20	MC-E=3	CE
48V	LED 8W	CRI>95
3XG2.03	on/off	
3XG2.G3	dimmable	
■ Led color	Nominal lm	▲ Beam spread
2 = 2700°K	829	S = 24°
3 = 3000°K	872	T = 8°

- Attention, before ordering the item:
- 1- Choose the appropriate 48V devices (75-100-150-200W) available on page 9, paying attention to the drop voltage table;
 - 2- If you need to dim the light, choose the two options:
 - a. by a Master DALI (item not supplied by Oty);
 - b. by our dimming device 3KIT.607.DIM, available on page 9.
 - 3- All our items are "Noise Free" dimming if installed as explained on page 8.



- Frame
- 02 ● Black
- 06 ○ White
- CH ● Chrome
- GD ● Gold



Standard: X-Gun is supplied with Anti-glare Ring



Option: Cross Anti-glare Ring

1XG2.C43.02

X-Gun 3 Ø 5,0

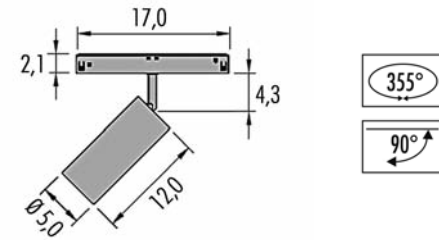

IP20	MC-E=3	CE
48V	LED 13W	CRI>95
3XG3.03	on/off	
3XG3.G3	dimmable	
Led color	Nominal lm	Beam spread
2 = 2700°K	1300	M = 38°
3 = 3000°K	1425	S = 24°

- Attention, before ordering the item:
- 1- Choose the appropriate 48V devices (75-100-150-200W) available on page 9, paying attention to the drop voltage table;
 - 2- If you need to dim the light, choose the two options:
 - a. by a Master DALI (item not supplied by Oty);
 - b. by our dimming device 3KIT.607.DIM, available on page 9.
 - 3- All our items are "Noise Free" dimming if installed as explained on page 8.



Standard: X-Gun is supplied with Anti-glare Ring



Option: Honeycomb cover Ø 38,5 mm

1XG3.H50.02



Option: Striped glass Ø 38,5 mm

1XG3.G50.ST

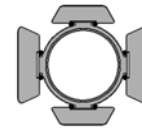

Option: Barn Door Ø 50,0 mm

1XG3.D50.02



- Frame
- 02 ● Black
- 06 ○ White

X - Gun 4 Ø 6,0

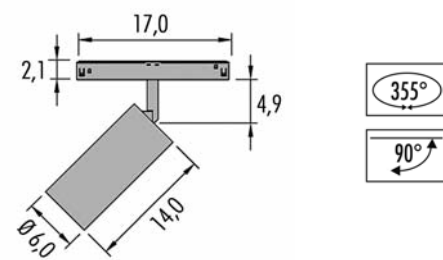

IP20	MC-E=3	CE
48V	LED 23W	CRI>95
3XG4.05	on/off	
3XG4.G5	dimmable	
Led color	Nominal lm	Beam spread
2 = 2700 °K	2131	S = 24°
3 = 3000 °K	2241	T = 15°

- Attention, before ordering the item:
- 1- Choose the appropriate 48V devices (75-100-150-200W) available on page 9, paying attention to the drop voltage table;
 - 2- If you need to dim the light, choose the two options:
 - a. by a Master DALI (item not supplied by Oty);
 - b. by our dimming device 3KIT.607.DIM, available on page 9.
 - 3- All our items are "Noise Free" dimming if installed as explained on page 8.



Standard: X - Gun is supplied with Anti-glare Ring



Option: Honeycomb cover Ø 52,0 mm

1XG4.H60.02



Option: Striped glass Ø 52,0 mm

1XG4.G60.ST

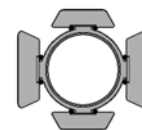

Option: Barn Door Ø 60,0 mm

1XG4.D60.02



□ Frame

02 ● Black

06 ○ White