

*Pop P122 - P202 Brooklyn*

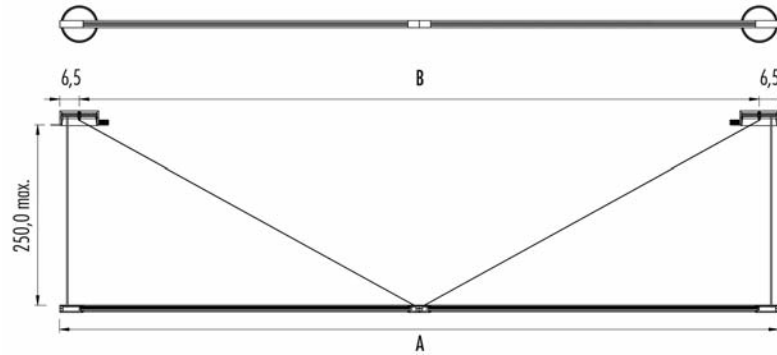



**Pop P122** ARC recessed canopy for plasterboard ceiling

IP20 ⓘ CE ▽ Ⓢ

220-240V 2x26W CRI>85

**3P122.43L** □

A = 240cm B = 227cm

Led color	Nominal lm	Beam spread
3000 °K	2x2350	106°

**3KIT.024.DIM**

Dimmable option:  
DALI - Push - 1...10V  
Remote installation - need 2 units to order

**Pop P202** ARC recessed canopy for plasterboard ceiling

IP20 ⓘ CE ▽ Ⓢ

220-240V 2x43W CRI>85

**3P202.43L** □

A = 384cm B = 371cm

Led color	Nominal lm	Beam spread
3000 °K	2x3915	106°

**3KIT.024.DIM**

Dimmable option:  
DALI - Push - 1...10V  
Remote installation - need 2 units to order

Housing for plasterboard ⤷ ∅ 14,0cm

**1Z00.120.01** ● x2 each

Housing for brickwork

**1M00.120.01** ● x2 each

□	Frame	ARC canopy	CUP canopy	cable
02 ●	Black	White	Black	Black
06 ○	White	White	White	White

Time delivery: 25 Working Days

# Pop P123 - P203

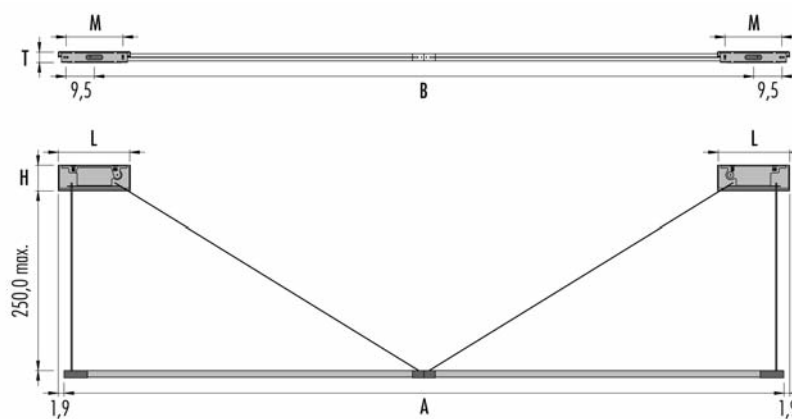

## Pop P123 CUP external canopy

IP20	ⓘ	CE	▽	⊕
220-240V	2x26W	CRI>85		
<b>3P123.43L</b> □ on/off				
A = 240cm B = 219,8cm				
L = 24,0cm H = 8,6cm T = 4,1cm M = 19,0cm				
■ Led color	Nominal lm	Beam spread		
3000 °K	2x2350	106°		

## Pop P203 CUP external canopy

IP20	ⓘ	CE	▽	⊕
220-240V	2x43W	CRI>85		
<b>3P203.43L</b> □ on/off				
A = 384cm B = 363,8cm				
L = 28,0cm H = 13,6cm T = 4,7cm M = 23,5cm				
■ Led color	Nominal lm	Beam spread		
3000 °K	2x3915	106°		

□	Frame	ARC canopy	CUP canopy	cable
02 ●	Black	White	Black	Black
06 ○	White	White	White	White

Time delivery: 25 Working Days





Pop P12 Ø 7,0

**Z00.120.01**  
Housing for plasterboard

**M00.120.01**  
Housing for brickwork



Pop P01 Dynamic Ø 12,5

**Z00.125.01**  
Housing for plasterboard

**M00.125.01**  
Housing for brickwork

Pop P04 Ø 12,0  
Pop P12 Ø 7,0  
Pop P12 Ø 12,5

Pop P122 Brooklin Arc  
Pop P202 Brooklin Arc

Pop P01 Static Ø 12,5  
Pop P01 Dynamic Ø 12,5  
Wally W01 Dynamic Ø 12,5

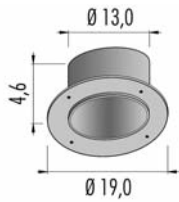

**1Z00.120.01**  
Ø 14,0 cm

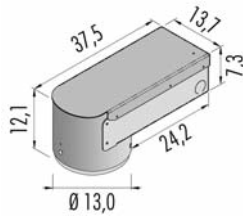

**1M00.120.01**

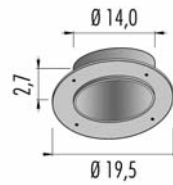

**1Z00.125.01**  
Ø 14,0 cm

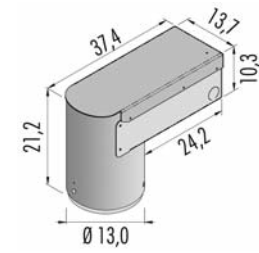

**1M00.125.01**

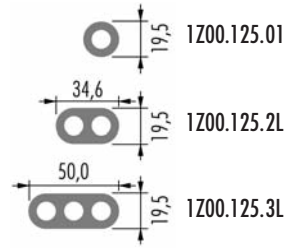
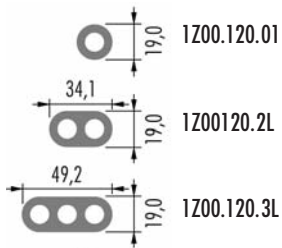

## Pop installation on plasterboard

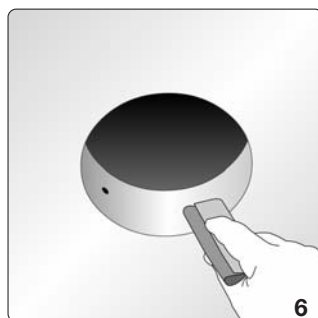
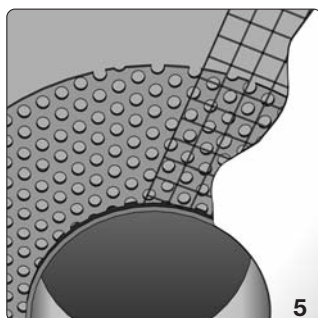
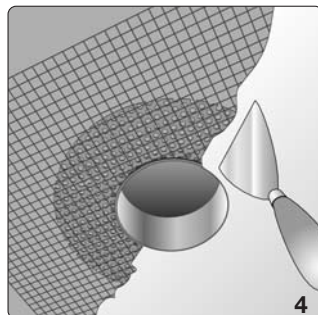
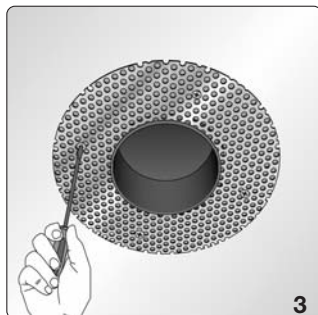
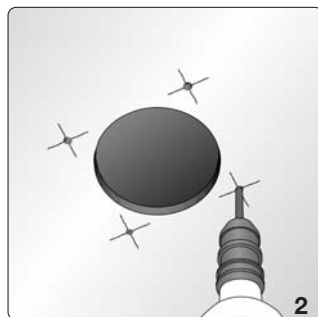
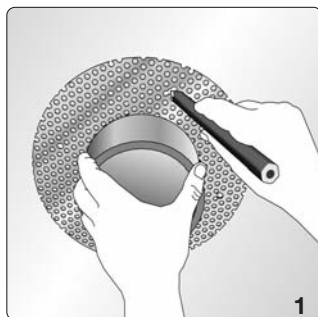

- 1) once pointed the position of the lamp mark the fixing holes for the housing
- 2) make the hole for the housing and the holes for the fixing rawlplugs
- 3) fix the screws of the housing to the ceiling plasterboard
- 4) apply the proper grasping net
- 5) plaster and trim the compensating 2 mm gap
- 6) keep clean the inside of the housing

Z00.030.01  
Z00.040.01  
Z00.055.XX  
Z00.060.01  
Z00.080.XX  
Z00.120.XX  
Z00.125.XX  
Z00.170.XX  
K00.170.01  
Z00.070.01  
Z00.043.01

## Pop installation on brickwork

Form a recess in the ceiling for the brickwork housing.  
Insert the power cables in to the brickwork housing and complete the ceiling with plaster finish.  
Keep the inside brickwork housing clean. Install the item into the housing.

M00.030.01  
M00.055.01  
M00.080.01  
M00.120.01  
M00.125.01  
M00.170.01  
M00.070.01

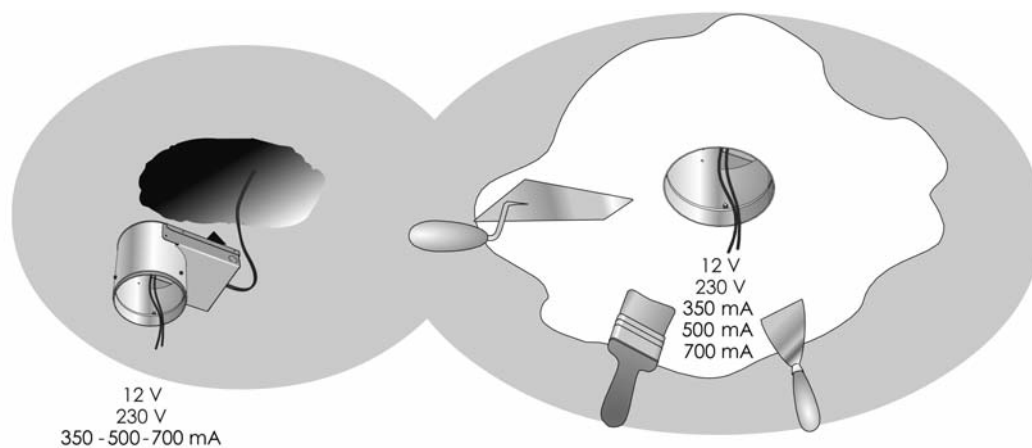

## Vademecum

### MC-E

MacAdams step:

é un parametro attraverso il quale si definisce il grado di decadimento del colore della luce di una sorgente led nel tempo.  
Lo step 3 rappresenta ad oggi il livello di decadimento più basso.

it is a parameter which defines the deterioration degree of the colour of the light coming from a led source during its life.  
Step 3 is nowadays the lower deterioration level.

es ist ein Parameter, der der Verschlechterungsgrad der Lichtfarbe eines Led Leuchtmittels während seines Lebens bestimmt.  
Step 3 ist heutzutage das niedrigste Verschlechterungsniveau.

Est un paramètre avec le quel on défini le degré de détérioration de la couleur de la lumière d'une source led dans le temps.  
Aujourd'hui le Step 3 est le niveau de détérioration le plus bas.

el es un parámetro que define el grado de deterioración del color de la luz de una fuente led en el tiempo. El step 3 representa hoy el nivel de deterioración más bajo.

### CRI

Indice di resa cromatica di una sorgente luminosa, e misura di quanto naturali appaiano i colori degli oggetti da essa illuminati.

Colour Rendering Index of a light source and measure indicating how natural the colours of objects appear when enlightened from it.

Farbwiedergabeindex einer Lichtquelle und Maß, das, wie nach der Natur die Farben der Objekten sich herausstellen, wenn sie von dieser Lichtquelle beleuchtet sind, anzeigt.

Indice de rendu des couleurs d'une source lumineuse et mesure qui indique la pureté des couleurs des objets éclairés par cette source.

Indice de rendimiento lumínico de una fuente luminosa, y medida de lo natural del color de los objetos iluminados con dicha fuente.

### lm

Il lumen è l'unità di misura del flusso luminoso di una sorgente luminosa.  
Lumen is the unit of the light flux of a light source.

Lumen ist ein Maß der Strahlengang einer Lichtquelle.

Le lumen est l'unité de mesure du flux d'éclairage d'une source lumineuse.

El lumen es la unidad de medida del flujo luminoso de una fuente luminosa.

### lx

Il lux è l'unità di misura per l'illuminamento di un'area piana.  
Un lux è pari a un lumen fratto un metro quadrato.

Lux is the unit for the lighting of a flat area. One lux is equal to one lumen divided per one square meter.

Lux ist ein Maß für die Beleuchtung einer ebenen Oberfläche.  
Ein lux ist gleich ein lumen geteilt durch einen quadratischen Meter.

Le lux est l'unité de mesure pour l'illumination d'une zone plane.  
Un lux correspond à un lumen divisé par mètre carré.

El lux es la unidad de medida de iluminación de una superficie.  
Un lux es equivalente a un lumen por metro cuadrado.



Classe I: Le componenti elettriche accessibili sono collegate ad un conduttore di terra.

Class I: Only basic insulation, accessible conductors are earthed. Earthing compulsory.

Klasse I: Grundisolation leitenden; berührbare Metallteile sind mit Schutzerdung verbunden. Schutzerdung vorgeschrieben.

Classe I: Seulement isolation de base, les parties conductrices accessibles sont reliées à un conducteur terre.  
Mise à la terre obligatoire.

Clase I: Sólo aislamiento fundamental; además, las partes conductoras accesibles están conectados a un conductor de tierra. Puesta a tierra indispensable.



Classe II: Messa a terra esclusa, sostituita da cavi elettrici con un isolamento rinforzato.

Class II: basic insulation plus second insulation or both are replaced by reinforced insulation. Earthing excluded

Klasse II: Entweder zu der Grundisolierung kommt noch eine zweite Isolierung hinzu oder ist eine verstrebtten Isolierung vorgesehen.

Classe II: Soit à l'isolation, soit ces deux dernières sont remplacées par une isolation renforcée.  
Mise à la terre: excluse.

Clase II: Al aislamiento fundamental se añade un segundo aislamiento, o bien los dos aislamientos se reemplazan por un aislamiento reforzado.



Classe III: Alimentazione a bassa tensione, inferiore a 50V-50Hz.  
Messa a terra non prevista.

Class III: Low tension inferior to 50V-50Hz. No ground cable.

Klasse III: Niedervolt < 50V-50 Hz, ohne Erdung

Classe III: Alimentation de sécurité à basse tension.  
Ne doit en aucun cas être utilisée pour des tensions supérieures à 50V-50Hz. mise à la terre.

Clase III: Alimentación de baja tensión, inferior a 50V-50Hz.  
Toma de tierra no prevista.



Apparecchio con caratteristiche per il montaggio diretto su superfici normalmente infiammabili (EN 60 598/VDE 0711).

Device which can be mounted on flammable surfaces (EN 60 598/VDE 0711).

Aparato con características para el montaje directo sobre superficies normalmente inflamables (EN 60 598/VDE 0711).



Prodotto conforme alle direttive europee.

Products complying with the Eur. Comm. rules.

Produkt gemaess den EU-Normen.

Producido conforme a las directivas europeas.



## IP identification

- Ⓒ** Driver incluso  
Driver included  
Treiber mitgeliefert  
Driver fourni  
Driver incluido
- Ⓒ** Driver non incluso  
Driver not included  
Treiber nicht mitgeliefert  
Driver non fourni  
Driver excluido
- Ⓓ** lampadina inclusa  
including bulb  
Leuchtmittel inklusiv  
ampoule comprise  
bombilla incluida
- Ⓓ** trasformatore incluso  
transformer included  
Trafo mitgeliefert  
transformateur fournie  
transformador incluido
- Ⓓ** trasformatore non incluso  
transformer not included  
Trafo nicht mitgeliefert  
transformateur non fournie  
transformador excluido
- IP0X** nessuna protezione  
no protection  
kein Schutz  
non protégé  
sin protección
- IP1X** protezione contro corpi estranei  $\geq 50\text{mm}$   
protection against solid objects  $\geq 50\text{mm}$   
Schutz gegen Fremdkörpern  $\geq 50\text{mm}$   
protection contre des corps étrangers  $\geq 50\text{mm}$   
protegido contra objetos extraños  $\geq 50\text{mm}$
- IP2X** protezione contro corpi estranei  $\geq 12\text{mm}$   
protection against solid objects  $\geq 12\text{mm}$   
Schutz gegen Fremdkörpern  $\geq 12\text{mm}$   
protection contre des corps étrangers  $\geq 12\text{mm}$   
protegido contra objetos extraños  $\geq 12\text{mm}$
- IP3X** protezione contro corpi estranei  $\geq 2,5\text{mm}$   
protection against solid objects  $\geq 2,5\text{mm}$   
Schutz gegen Fremdkörpern  $\geq 2,5\text{mm}$   
protection contre des corps étrangers  $\geq 2,5\text{mm}$   
protegido contra objetos extraños  $\geq 2,5\text{mm}$
- IP4X** protezione contro corpi estranei  $\geq 1\text{mm}$   
protection against solid objects  $\geq 1\text{mm}$   
Schutz gegen Fremdkörpern  $\geq 1\text{mm}$   
protection contre des corps étrangers  $\geq 1\text{mm}$   
protegido contra objetos extraños  $\geq 1\text{mm}$
- IP5X** protezione da polvere  
dust-protected  
Staubgeschützt  
protection contre la poussière  
aparato protegido contra el polvo
- IP6X** stagno alla polvere  
dust-proof  
Staubdicht  
hermétique à la poussière  
aparato totalmente protegido contra el polvo
- IPX0** nessuna protezione  
no protection  
kein Schutz  
non protégé  
sin protección
- IPX1** protezione contro caduta acqua verticale  
protected against water drops falling vertically  
Schutz gegen Wassertropfen, die senkrecht herabfallen  
protégé contre les gouttes d'eau tombant verticalement  
protegido contra la caída de gotas de agua
- IPX2** protezione contro caduta di gocce oblique a  $15^\circ$   
protected against water drops max inclination  $15^\circ$   
Schutz gegen Wassertropfen, die senkrecht herabfallen Neigung  $15^\circ$   
protégé contre les gouttes d'eau à inclinaison maximale de max  $15^\circ$   
protegido contra la caída de gotas de agua con inclinación max  $15^\circ$
- IPX3** protezione contro caduta di gocce oblique a  $60^\circ$   
protected against water drops max inclination  $60^\circ$   
Schutz gegen Wassertropfen, die senkrecht herabfallen Neigung  $60^\circ$   
protégé contre les gouttes d'eau à inclinaison de max  $60^\circ$   
protegido contra la caída de gotas de agua con inclinación max  $60^\circ$
- IPX4** protezione contro spruzzi d'acqua  
protected against sprinkling water  
Spritzwassergeschützt  
protégé contre les éclaboussures  
aparato protegido contralasalpicaduras
- IPX5** protezione contro getti d'acqua  
protected against water jets  
Wasserstrahlgeschützt  
protégé contre les gouttes d'eau  
aparato totalmente protegido contra los chorros de agua
- IPX6** protezione contro inondazioni  
Protected against flooding  
Überschwemmunggeschützt  
rotected against flooding  
aparato totalmente protegido contra
- IPX7** protezione per immersione temporanea  
protected against brief immersions  
gegen kurzen Tauchen geschützt  
hermétique à la immersion  
aparato totalmente protegido contra la sumersión
- IPX8** protezione per immersione costante  
protected against long immersion  
Tauchengeschützt  
protégé pour des immersions prolongées  
aparato totalmente protegido contra la larga imersión